



Battery Powered RC Boats: A Review of Its Developments for Various Applications

C. Z. Eugene¹, J. J. Lim¹, Umar Nirmal^{1*} and Saijod T. W. Lau¹

¹*Centre of Advanced Mechanical and Green Technology, Faculty of Engineering and Technology, Multimedia University, Jalan Ayer Keroh Lama, Melaka 75450, Malaysia.*

Authors' contributions

This work was carried out in collaboration among all authors. Authors CZE and JLL performed a comprehensive review on the development of battery powered boats for various applications. Authors UN and STWL supervised the work and designed the contents in this article. All authors read and approved the final manuscript.

Article Information

DOI: 10.9734/CJAST/2019/v33i530098

Editor(s):

(1) Dr. Chien-Jen Wang, Professor, Department of Electrical Engineering, National University of Tainan, Taiwan.

Reviewers:

(1) J. Dario Aristizabal-Ochoa, National University of Colombia, USA.

(2) Şükrü Kitiş, Dumlupınar University, Turkey.

Complete Peer review History: <http://www.sdiarticle3.com/review-history/47791>

Review Article

Received 19 November 2018

Accepted 02 March 2019

Published 15 March 2019

ABSTRACT

This paper presents a review of the developments in the battery powered remote control (RC) boat for various applications. In recent time, RC boat stands no more a mere toy or instrument that is solely used for a hobby. Various researches into the applications of RC boats have been undertaken in recent years and its performance has been a continuous growing concern for society. Many researchers have also exerted strenuous efforts into modifying the shapes and materials that are used to manufacture the boat hull, in order to improve its efficiency. In lieu to this, this paper provides information on different types of boat hulls and their characteristics. Knowing the fact that the performance of the RC boat has been directly affected by its component parts such as the motor, ESC, rudder, propeller and others, the paper highlights an overview of the RC boat's basic components and its setup. Owing to the review works presented, future research is proposed which may open new research pathways to the subject of interest.

Keywords: RC; boats; hull; applications; electrical; electronic; setup; future research.

**Corresponding author: E-mail: nirmal@mmu.edu.my;*

1. INTRODUCTION

A boat, according to the Cambridge English Dictionary, is defined as a small vehicle that is used to travel on water. Humans cannot walk on water. Hence a vessel is employed to travel across water. This is essential to human race as over 70% of the Earth's surface itself is covered in water [1]. Some may be confused between a boat and a ship. In general terms, they are both vehicles used for travelling on water. However there exists a thin and fine line that separates the two, which often results in confusion. The most significant difference between a boat and a ship is the difference in their size. A ship is a large ocean going vessel whereas a boat is comparatively smaller in size. The best way to differentiate between a boat and a ship is by memorizing the sayings: "You can put a boat on a ship, but you can't put a ship on a boat" [2]. Apart from their size, another major difference between a ship and a boat is their operational areas. Ships are vessels that operate in oceanic areas and high seas [2,3]. Owing to its size, a ship can travel a far distance without experiencing a shortage in fuel and it can further withstand higher pressure from waves in the ocean. Ships are thus mainly built for cargo or passenger transportation across oceans. Boats in contrast, typically operate in a smaller or more restricted water areas. Due to their smaller size, boats can be easily controlled in restricted water areas. In most cases, boats are mainly used for smaller purposes and typically operate nearer to the coast.

A remote controlled boat, in short, a "RC" boat is the scaled-down version of an actual boat, that is equipped with radio control equipment [4]. The size of a RC boat is relatively smaller in comparison to a normal boat as it is neither purposed to transport passengers nor cargo. A RC boat may be controlled via a radio receiver and transmitter. It can be controlled by a user remotely or at a defined range. This range often varies from a few meters to a few hundred meters [5]. The receiver is mounted on the boat and connected to the rudder and motor of the boat. The user can control the speed and direction of the boat remotely by sending radio signals through the transmitter. In some cases, an antenna is also usually installed onto the boat to increase the accuracy and range of the boat. RC boats are largely powered by rechargeable batteries and gasoline. In certain advanced models, the RC boats could also be solar powered.

The history of boating dates back to even before the dawn of the prehistoric period. Two sites on the Indonesian Island of Flores evidence that *Homo erectus* the earliest species in the human lineage that have many human-like qualities [6], were able to navigate through water as early as from 500,000 to 400,000 years ago [7]. Boats naturally did not appear right away with the sophisticated shapes that are available in nowadays. It all began with a humble design. Whether it be tying some logs together to form a raft or digging out a log to form a canoe; ancient civilizations created these watercrafts mainly to transport across water [7–10]. In the ancient times, boats were created for merely one purpose: to float on water. Raft propulsion is mainly achieved by pushing with poles, pulling with ropes or by paddling [11]. Primitive log rafts had no keel or shapes that keep them moving in a straight line. Hence it was difficult to steer and navigate through a water surface. With the advancement of knowledge and technology over the years, many aspects were taken into consideration when designing and building a boat. This led to a drastic change in the shape and function of a boat. Boats began to have sharp narrow bows that could cut through water when travelling in a straight line. Sails were later introduced as a propulsion method and it greatly decreased the need of human strength for poling.

Despite the uncontested fact that a RC boat was not as popular as a RC car or drone due to its confined area of use, but being a marine vehicle; the importance of RC boat was nevertheless indispensable. The origin of this invention dated back to a thousand years ago.

The first RC boat was created in 1898 by Nikola Tesla (Fig. 1). It was one of the earliest application of wireless control, even before the RC plane and RC car were invented. During his scientific Tour de France in New York's Madison Square Garden, Tesla stunned the crowd by showing them the first-ever remote controlled vessel. Using a small radio transmitting device he was able to maneuver and flash the lights of a tiny boat on a pool of water without any visible connection between the boat and the controller [12,13]. When he first created the RC boat, he aimed to create an automation that could help reduce the laborious work of the human race. But the eyes of others, saw something much sinister: a war machine. Unfortunately, the significant parts of his ideas were however concealed. They were not even explained in his patent in fear that this invention would be "stolen" like many other

of his inventions were in the past. Therefore the development of the remote control was severely delayed.

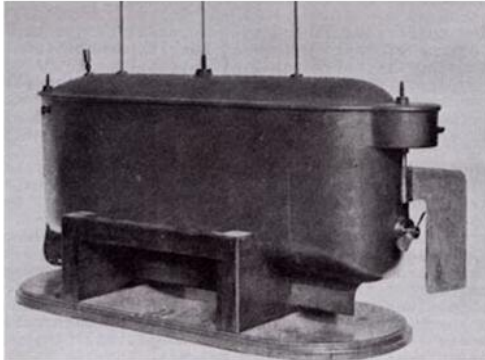

Fig. 1. Nikola Tesla's first remote control boat [14]

In the early 1950s, the advent of the transistor which effectively reduced the requirement for batteries, led to the general and commercial use of a remote control. This invention increased the popularity of remote control vehicles which included remote control boats. This remains so till today as there is continuous development of the remote control boat and the component setup of the RC boat has also been undergoing continuous modifications in light of the availability of new technologies.

According to the Google search engine, there were 87 articles published on the RC boat alone from 2008 to 2018, as illustrated in Fig. 2. Beginning 2008, the number of articles published

was 2 and the trend was on an increase from 2008 to 2018. The results show that there were 19 articles published related to the RC boat in 2018. In this paper, focus is emphasised on the years 2008 to 2018 and the results reflect that society has begun to be more attentive to the development of RC boats.

The purpose of this review is to provide an effective overview on the research conducted into RC boats for the past 10 years and to address the basic component configuration of the RC boat, the characteristics of different types of components and their design consideration on torque, efficiency, dimension, power supply and their applications. Following the review process, the basic setup and installation of the components will also be addressed appropriately and the writers' views on the potential application and future research into RC boats will also be posited and discussed with the hope that it will assist in further research into RC boats and their composites.

2. Type of Boats

RC boats may be classified into various types through the shape of their hull. Different types of boats have different specifications and applications. The three major types of boats are hydroplanes, monoplanes/monohull or multi-hulled. These three major types can be further differentiated by examining their characteristics. The various types of boat are shown in the flowchart (Fig. 3).

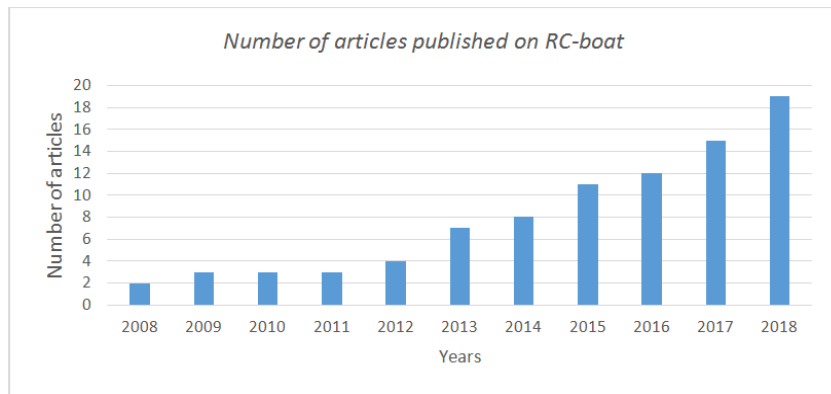

Fig. 2. Number of articles published on RC-boat from 2008 to 2018

Remark: Search Engine used: Google; Key words used: -research on remote control; -RC boat; - electrical and electronic setup

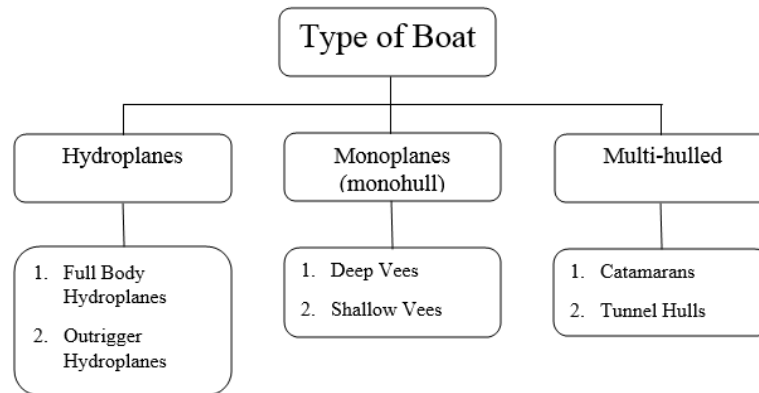

Fig. 3. Flowchart showing various type of boat

2.1 Hydroplanes

2.1.1 Full body hydroplanes

Full body hydroplanes or also known as sport or scale hydroplanes, have hulls that are full bodied and which resemble a full scale boat as shown in the fig. 4. This type of boat is one of the fastest out of all scale hulls. It rides on a cushion of air and only a small part of its sponson touches the water via propulsion [15,16]. Because only a little part of the boat is immersed in water, there is thus only a little drag acting on the hull; making it the fastest of all scale hulls. One of the challenges with full body hydroplanes is that they often result in blowing over and crashes. This is because as a full body hydroplane builds speed, it traps air under the hull hence causing it to easily blow over. The weakness of a full body hydroplane is that it only turns well in one direction, typically better to its right than its left. A full body hydroplane also requires a flat water surface to run because windy conditions may cause blow overs, and choppy waters may cause the nose to dive into the waves.



Fig. 4. Full body hydroplane [15]

2.1.2 Outrigger hydroplanes

Outriggers are usually described as a counterpoising float rigged out from the sides of the boat that provide better stability. Some boat have two outriggers. One on each side of the boat. While others, have a single outrigger which is mostly but not always, kept to windward [17–21]. Fig. 4 shows an outrigger hydroplane with two separate identical floats on each side of the boat. Because of the open distance between the centre of the boat's body and the outriggers, this hull type packs less air as compared to a full body hydroplane. This allows it to achieve high speeds with slimmer chances of blowing over. Outrigger hydroplanes are one of the fastest boats in RC boat hobby. Some outriggers are capable of achieving speeds well over 100mph and its turning speed is almost as fast as it goes in a straight line. Although an outrigger hydroplane comes with amazing speed, it also nevertheless has some weaknesses. Outriggers do not tolerate rough waters well and are finicky to tune. Calm water surfaces are crucial for an outrigger to achieve its maximum speed. In any case, outriggers also possess the same weakness as other hydroplanes — which is that they only turn well in one direction.

2.2 Monoplanes (Monohulls)

Monoplanes which are also known as mono, are a type of boat hull that have a single-plane surface and are sometimes called 'V' hulls. Their inner space is relatively large as compared to other types of hulls and thus eases the installation of any type of engine. A mono also compresses air as it runs but diverts this air off the sides as the boat build speed, rather than trapping the air beneath the boat [23]. Most

monoplanes have strakes, as shown in Fig. 5, that help to shear the water from the bottom of the boats as it moves. This design creates a lift force that then raises the boat by a small distance above the water surface. Mono can turn well in both directions and are able to handle choppy as well as rough water surfaces. It is therefore a more suitable option as compared to hydroplanes when it comes to rough waters that require the boat to turn equally well in both directions. This is thus the best hull design for beginners.



Fig. 5. Outrigger hydroplane [22]

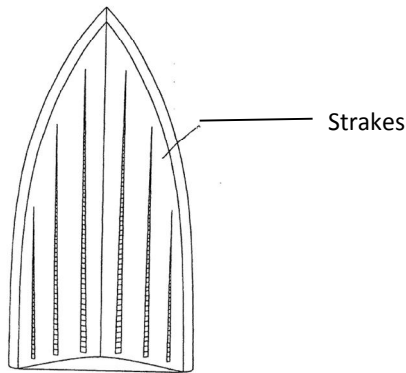

Fig. 6. Strakes on the bottom of a boat [23]

2.2.1 Deep vee

The angle between a horizontal plane and the hull varies from 16° to 28° [24]. This design is able to cut the water surface when operating and is well known for its excellent handling, easy drivability and ability to handle choppy and rough water surfaces.

2.2.2 Shallow Vee

The angle of this is smaller than that of the Deep Vee which is lower than 16° [24]. This design can achieve a higher speed as compared to the Deep

Vee but in turn, it is also trickier to adjust and handle.

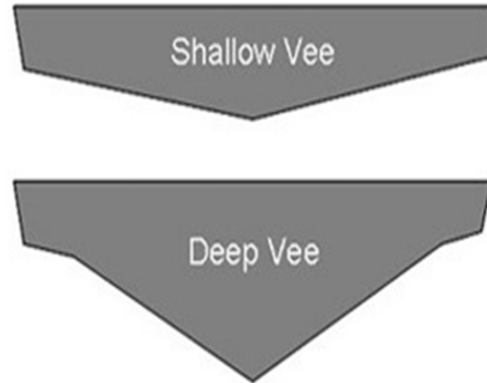

Fig. 7. Illustrated comparison between a Shallow Vee and a Deep Vee hull [24]

2.3 Multi-hulled

As its name suggests, a multi-hulled is a boat with two or more hulls [25–27]. The number of hulls varies from two to five with different arrangements and shapes. The most commonly known multi-hulled is the catamaran which comes with two parallel hulls of equal shape. A multi-hulled design is comparatively harder to maneuver and fabricate due to its complex shape.

2.3.1 Catamarans

Catamarans, or also known as cat, is a hybrid between a hydroplane and a deep vee (Fig. 7). The catamaran hull consists of two hulls called sponsons that are connected together by an elevated superstructure [24,28–31]. The superstructure creates a tunnel that allows air to pass through and thus creates a lift force that exerts onto the hull and reduces drag towards the boat and increases its performance. The cat has similar properties to the hydroplane. The main difference between the two is the length of their sponsons. Sponsons on a cat run the full length of the boat as shown in Fig. 8. The twin hulls design make it both faster than a deep vee with the added benefit of better tolerance on rough water surfaces than a hydroplane. However similar to a hydroplane, the cat is also susceptible to blow overs. Cats can turn equally well in both directions and are therefore more stable than a mono at high speeds due to its twin hull design.



Fig. 8. Catamaran hull [30]

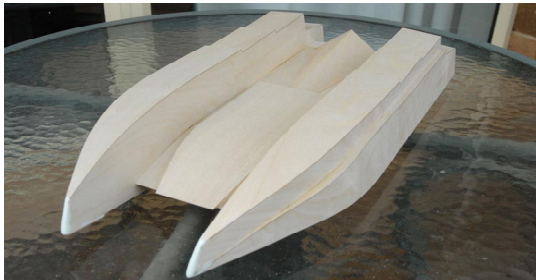

Fig. 9. Bottom of a catamaran hull [32]

2.3.2 Tunnel Hulls

Tunnel hulls have twin style hulls similar to a catamaran. Most of the RC boat designs have their propulsion systems disguised and hidden in the hull. But almost all tunnel hulls use an exterior motor for propulsion [33]. Because of the low profile of the hull, the tunnel hull will not overcome the waves very well. Facing the same limitation when it comes to rough water surfaces, tunnel hulls are much slower than hydroplanes,

but they do provide a far better turning circle. Tunnel hulls handle turns well towards both their left and right directions.



Fig. 10. Tunnel hull RC boat [33]

3. BASIC COMPONENTS IN A BATTERY POWERED RC BOAT

The basic components of a RC boat are shown in Fig 11. Typically, a RC boat is composed of several components such as the motor, electronic speed controller, rudder, propeller, servomotor, power sources, and a transmitter and receiver. All of these components are important to the RC boat building given that all of these components have a significant impact on the RC boat's performance. This is because all of these components work interrelated when the RC boat is in operation. All of these components are now examined in turn in the following section of this paper.

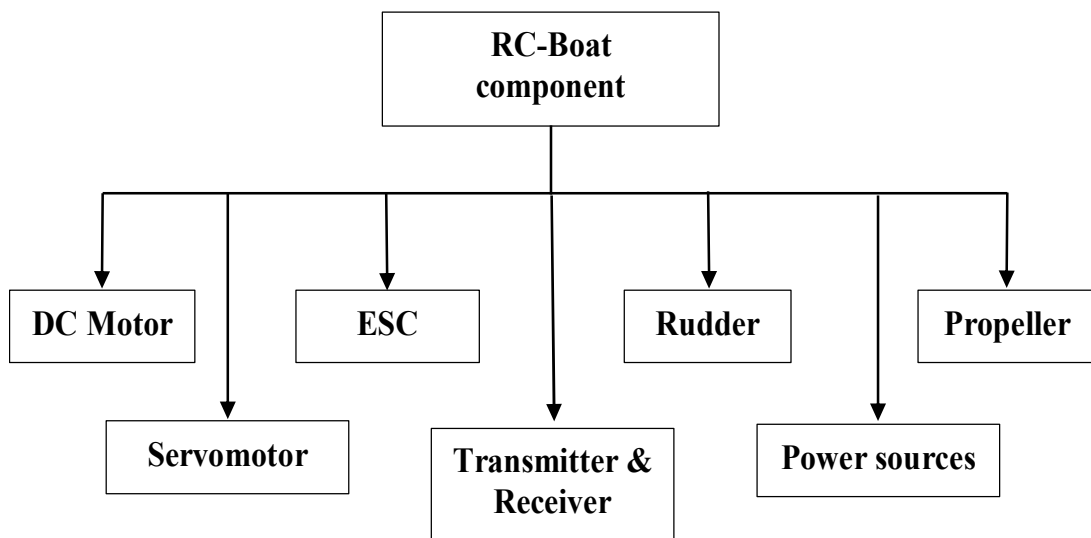

Fig. 11. Basic components of RC boat
 Remark: ESC - Electronic Speed Controller

3.1 Motor

The motor is used to convert electrical power from batteries to mechanical power in the form of rotary motions for propulsion purposes. The motor is characterized by a few specific parameters such as no-load and stall speed, torque, current, and voltages, as well as the power factor. These parameters are important in order to predict the performance of a DC motor. DC motors can be divided into two main classes as shown in Fig. 12 which are a brushed DC motor and a brushless DC (BLDC) motor.

A brushed motor is composed of a stator, rotor, commutator and brushes. Stationary magnetic energy is generated by either an electromagnetic winding or by permanent magnets in a stator portion [34]. The electromagnetic winding can be shunt, series, or compound coil wound stators. However, in many applications, permanent magnets are preferred as they may be fitted into smaller sizes, carry less weight, are more efficient, and have a better cost-to-performance ratio than an equivalent wound field motor [35,36].

The rotor contains an armature wound with copper coils. When energized, the armature will produce a magnetic field that attracts the opposite pole of a magnetic field in a stator portion thus causing the rotor to run. When the magnetic equilibrium position is approached, the rotor winding's magnetic polarity is reversed via the commutation and rotor will run in opposite direction until a new equilibrium position is reached.

By altering the applied voltage, the brushed motor speed may be controlled easily, which is a great advantage compared to a brushless motor as it requires a three-phase speed controller. Basically, a brushes motor has a low construction cost. However, there are some trade-offs for the brushed motor. Friction contact of the brushes cause them to wear over time and once they are damaged, either the brushes or the motor will have to be entirely replaced. Heat generated during the brush arcing and the current flowing through the winding also limits its performance. Furthermore, electronic noises and electromagnetic interference (EMI) generated during brush arcing may also interfere with applications that have sensitive electronic sensor or radio communications [37].

Brushless motors are synchronous motors. This means that the magnetic field generated by the stator and rotor rotate at the same frequency. The winding in stator is energized in a sequence. For each sequence of commutation, one winding must be energized to a power position, the second winding to a negative and the third remains in a non-energized condition. The interaction between the magnetic field in the stator portion and the rotor portion causes the motor to run and the magnetic field generated by the winding must keep shifting position to keep the motor running. Due to a lack of brushes, a hall effect sensor which is embedded into the stator is used to identify the position of the rotor [38,39]. When magnetic poles of the rotor pass near to the sensors, hall sensors then indicate the pole and send a high or low signal [40].

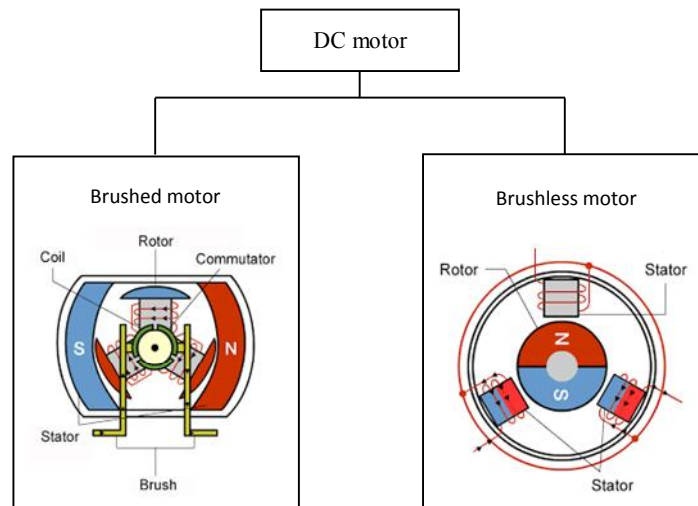

Fig. 12. Classification of DC motor

Eliminating the need of brushes and commutator in these motors thus results in an increase in their efficiency as there is no voltage drop during commutation. Further, internal friction due to presence of brushes is also reduced thereby allowing for higher speed, lower electrical noise and a reduced EMI. However, brushless motors require a much more complex electronic speed controller, and these controllers are expensive and are as heavy as motors themselves.

3.2 Rudder

Manoeuvrability is one of the critical factors in boat designing [41]. Even though various steering devices are available in the market, rudders however are still the main steering devices for ships [42]. The thrust efficiency and ship resistance can be directly affected by its rudder design and therefore rudder selection is important to provide a sufficient turning torque and bending in manoeuvrability. The propeller-rudder system (PRS) is a propulsion plan that is used to optimize the interference of hydrodynamics between the rudders and the

propellers [43]. In PRS, the rudder is classified based on the position of the stock and the structure of rudder-hull connection.

3.2.1 Rudder types

The following section describes the different types of rudders with their main working principal.

3.2.2 Fully balanced rudders

A balanced rudder as shown in Fig. 13 (a) is a rudder in which the axis of rotation lies at 20% - 0.37% chord length from the leading edge. Typically, the turning torque acting on the balanced rudder is lesser than that of an unbalanced rudder since the force acting on the rudder may either partially or fully be compensated at a certain angle by the force acting on the rudder area which is in front of the axis of rotation. However, it is impossible to balance the rudder at every moment since the force acting point is affected by the rudder angle. Balanced rudders have been extensively applied to single-propeller merchant ships.

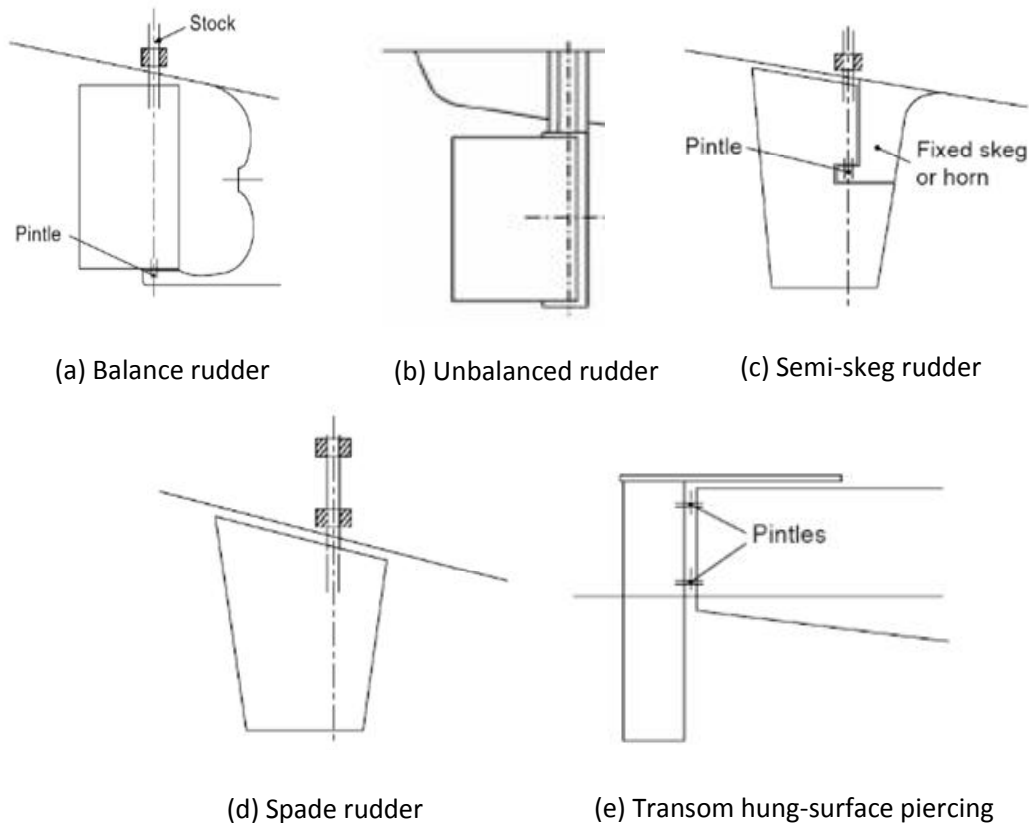

Fig. 13. Different types of rudder in a conventional propeller-rudder systems [44]

3.2.3 Unbalanced rudders

The unbalanced rudder is a rudder whose stock at the leading edge of the rudder and the entire area of the rudder is made after the stock shown in Fig. 13 (b). Unlike balanced rudders, all the turning torques acting on the rudder ought to be provided by the steering gear and therefore the size of an unbalanced rudder is limited otherwise it cannot work properly. There are pintles located on the tip and the root of an unbalanced rudder in order to overcome the large bending moment and this protects the rudder from damage. Although unbalanced rudders only work for limited areas, they are however still popular for smaller crafts or fishing vessels due their low cost and easy production. The transom hung-surface piercing shown in Fig. 13 (e) is one of an unbalanced rudder which is commonly used in a RC boat.

3.2.4 Semi-skeg rudders

A Semi-skeg rudder is shown in Fig.13 (c). It is better known as a horn rudder or Mariner rudder. It is a semi-balanced rudder whose movable part of the rudder is supported by a fixed skeg and pintle located at the bottom of the skeg [44]. Being a combination of a balanced rudder and an unbalanced rudder, semi-skegs can perform at less turning torque than an unbalanced rudder and less bending moment than the spade rudder. A large rudder is possible for the semi-skeg rudder as the spanwise bearing moment is supported by the horn. However, the horn results in a change in the coefficient of the lift and drag although it does not incline. The maximum lift, lift-to-drag ratio, and lift curve slope of semi-skeg rudder is smaller than all-moveable rudders having the same size.

3.2.5 Spade rudders

The spade rudder which is shown in Fig. 13 (d) is a balanced rudder with a taper ratio. Rudders with large taper ratios may reduce the rudder drag or even generate thrust. In a spade rudder the stock will carry the bending moment and torque on the rudder itself, and therefore a larger stock diameter and rudder thickness is required. Spade rudders with a stock diameter larger than 1m are not feasible. Spade rudders suffer from less turning torque than unbalanced rudders and therefore less energy is needed. Meanwhile, the power consumed by the steering gear is also decreased given that spade rudders do not have gap cavitations like the semi-skeg and full skeg

rudder. Therefore this allows spade rudders have better durability. In modern times, spade rudders have become popular in all ship typed applications.

3.3 Rudder Profile

Rudder profile is the sectional shape of the rudder which has to be decided in the initial stage of designing the rudder as it holds great influence over boat's hydrodynamic performance [45]. Various types of rudder profile series are available in boat building based on the different distributions of a boat's thickness and camber.

3.3.1 National advisory committee for aeronautics (NACA) profiles

NACA profiles are rudder profiles that are widely applied in boat design. Generally, this profile is used when there is no specific requirement on the rudder type or economical purpose. The section of the NACA series rudder is wider than rudders on an air-plane and the shape of rudder edge may also vary depending on the ship's series which allows the rudder to have greater strength and the stall decreased [45]. Various test have been carried out on the NACA profile ship rudder, such as Whicker and Fehlner in 1958 and Thieme in 1965 [46,47] and it can be generally seen that NACA profile generate sufficient maneuvering force with a high efficiency. The NACA series rudder profile is the most efficient profile that is suitable for fast speed RC boats and can provide sufficient lift with minimum drag. Especially the NACA 65/66 series which are commonly used for high-speed boating but they nevertheless remain vulnerable to cavitation [48].

3.3.2 Hamburgische schiffbau-versuchsanstalt gmbh (HSVA) profiles

HSVA profiles are a kind of ship rudders developed by the Hamburg Ship Model. HSVA series was designed in order to reduce the onset cavitation and allow for better pressure distribution. Basically, the high-lift HSVA profiles may achieve 1% power saving by a rudder area reduction [49].

3.3.3 Institute für schiffbau (IFS) profiles

IFS profiles are a series of profiles developed by Institute für Schiffbau, Hamburg to achieve a steep lift curve slope, a large stall angle, and a high maximum lift coefficient. Compared to the

HSVA profiles, IFS profiles may generate slightly more lift, induce more drag, and typically suffer from less cavitation.

vessels. They are seldom used on seagoing ships.

3.3.4 Flat-plate profiles

Flat-plate profiles typically come in the shape of a rectangle plate. They are the simplest design, easier to fabricate and are generally cheaper than other types of profiles. Certain flat-plate profiles may have their leading in a semicircle or triangle shape or trailing edges with faired tips. Flat-plate profiles are suitable for straight-ahead conditions due to their high efficiency [47] however they are limited to small angles of attack. Once the angle of attack is more than 5 degrees, the lift-to drag ratio collapses and the lift coefficient stalls [50]. The earlier and stronger flow separation causes the flat-plate to stall at a smaller angle as compared to the other profiles. The flat-plate rudder is thus commonly applied on smaller boats and antique inland

3.4 Propeller Design

The essence of a remote boat propulsion is the conversion of the motor power into thrust force through the use of a propulsion device [51]. Due to its simplicity and efficiency, the propeller has become the most widely used propulsive device. During the design or propeller selection process, the design factors as shown in Fig. 14 should be considered in order to achieve the highest efficiency. These design factors are diameter of the propeller, rotational speed, pitch diameter ratio and the blade numbers. These factors, in combination, impose a thrust force on the propeller shaft. This thrust is then transmitted through the shaft to the thrust bearing — the principle point where the force is generated by the rotating propeller acting upon the hull, and hence resulting in a forward motion [52].

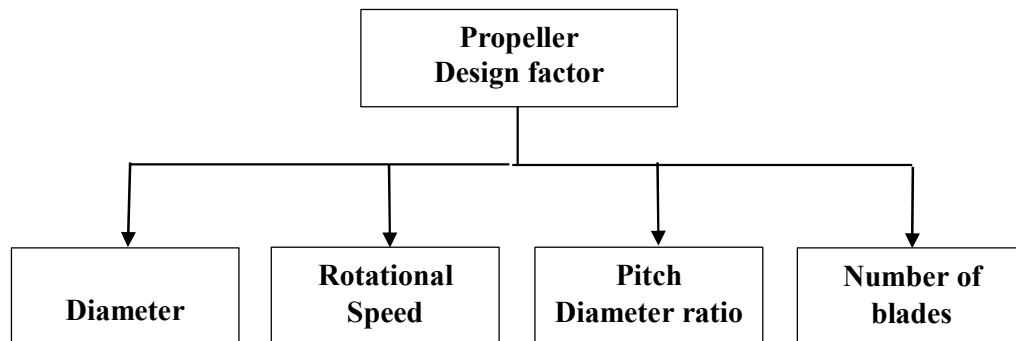

Fig. 14. Propeller design factor

3.4.1 Diameter

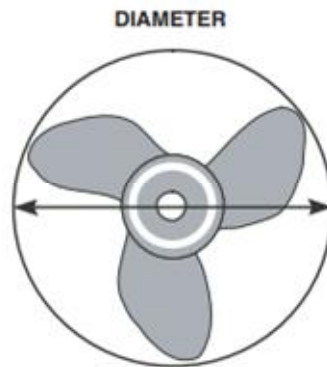

Fig. 15. Diameter of propeller [53]

The diameter of the propeller as illustrated in Fig. 15 is a critical geometric parameter of propeller building that directly affects the amount of power that a propeller absorbs and delivers; and that resultantly thrusts the boat for propulsion. In essence, the propeller efficiency is directly proportional to its diameter. A larger diameter will lead to greater efficiency as more incoming fluid is caught and thus it distributes the power and thrust to a larger fluid volume [54]. This concept was limited for vessels with speeds below 35 knots. For speed vessels with speeds above 35 knots, an excessive drag will be produced. A small increase in diameter will increase the thrust and torque dramatically on the shaft and engine. Therefore, a lower RPM ought to be applied [55]. Typically, a larger diameter is suitable for heavy loads whilst a smaller diameter may be applied on high speed boats to achieve more efficiency [53].

3.4.2 Rotational speed

Revolution per minute (RPM) means the number of full rotations a propeller makes in a single minute. RPM is also sometimes known as shaft RPM or tail-shaft RPM as the propeller shaft rotates at the same speed as the propeller. In fact, the shaft's RPM is always different from the motor's RPM. Typically, high RPMs are not efficient save for on high-speed boats. For boats with speeds under 35 knots, a reduction in the RPM and an increase in diameter; results in a higher torque.

3.4.3 Pitch to diameter ratio

Pitch is the theoretical distance that moves the boat forward during one revolution. In fact, the actual distance travelled by the boat in one rotation is less than the pitch due to the occurrence of a slip [53]. Pitch can convert the propeller shaft torque to thrust effectively by accelerating or deflecting the water astern. The pitch diameter ratio p/d , is the ratio of the pitch to propeller's diameter. The pitch's diameter ratio is important at the initial design stage and typically falls between the range of 0.5 – 2.5 mm [56]. A lower pitch is able to reach the maximum RPM quickly, and thus provides faster acceleration but is slower in top speed and vice versa for a higher pitch. A study done by Kiam Beng Yeo, Wai Heng Choong and Wen Yee Hau to predict the hydrodynamics performance of a marine propeller through CHF found that an increase in pitch diameter ratio can improve the efficiency, thrust and torque of the propeller [57]. Basically,

each inch of the pitch is worth about 150-200 RPM.

3.4.4 Number of blades

Theoretically, the propeller becomes most efficient when the number of its blades is fewest. However, an increase in the number of blades on the propeller is needed for certain conditions to provide a sufficient blade area to generate effective thrust. The sheet cavitation can be reduced through an increment in the number of blades because the load on each blade will be reduced. On the other hand, increasing the number of blades also leads to root cavitation increase as clearance between blades get closer and thus creates additional turbulence, scrambling up one another's water flow [58,59]. Generally, three blade propellers provide the best performance balance in various applications in terms of efficiency and smoothness [53].

3.5 Electronic Speed Controller (ESC)

The electronic speed controller (ESC) is a component that is used to provide a link between the power source and the motor within the powertrain of a remote control boat. The power output and rotational speed of the motor is controlled by the ESC in response to the operator's command by varying the width of the Pulse Width Modulation (PWM) pulses [60]. Brushed and brushless motors operate in different ways. Electronic speed controllers were therefore designed specifically for either brushed motor or brushless motor. Hence, ESC can be classified into brushed ESC and brushless ESC. A Battery Eliminator Circuit (BEC) is commonly used in modern ECS to regulate a stable voltage to run the receiver and servo thereby eliminating the requirement for a separate battery and receiver. Therefore, ESC may be further classified into linear or switch BEC and all the classifications of the ESC are illustrated in Fig.16.

3.5.1 Brushed ESC

The speed of a brushed motor is proportional to the power sources applied across the motor. Thus, the speed of the motor may be simply varied by adjusting the voltage applied. PWM signals which are based on a fixed frequency pulse waveform with a variable duty cycle are implied in electronic control to generate an average voltage and the motor winding treat as low pass filter ensure that stable current in winding can be generated. The average voltage

applied is directly affected by the duty cycle of the PWM proportionally [61].

3.5.2 Brushless ESC

An ESC is used in brushless motors to control the three phase waveform and the three phases signal is then modulated by a series six metal-oxide-semiconductor field-effect transistors (MOSFETs) and diodes. When a DC power source is applied to the brushless ESC, the input power is converted into a 3 phase AC power output to run the motor by sending a sequence of AC signals generated from the ESC's circuitry.

There are three wires connected to the brushless motor. However only two of these wires are energized all the time. The pole that is not energized generates a small amount of voltage known as Back Electromotive Force (EMF) which is proportional to the speed of the motor spinning and this voltage is used to determine the rotating speed and the direction of the motor at any given time. The applied voltage is combined with the back EMF to create a trapezoidal wave, thus the three-phase, trapezoidal wave, unipolar

or voltage signal are commonly used as the controller's output waveform [62].

3.5.3 Linear battery eliminate circuit (LBEC)

A Linear BEC is used to force a desired voltage into appearing at the output terminal by using a voltage-controlled source of current. The output voltage is monitored by the voltage regulation loop, and the desired value of output voltage is reached by adjusting the current sources [63]. However, the input voltage of LBEC must be greater than the desired output voltage [64]. Linear BEC may face problems of excessive power dissipation when there is a huge difference between the input and output voltages. The excess voltage is converted into heat thus decreasing its efficiency. When higher input voltage is supplied, more power will be converted into heat. An overheated BEC may result in thermal-shutdown thus causing a loss of power to the controller and radio receiver, and eventually resulting in a crash. However, for applications in which the output voltage is very close to the input voltage, the Linear BEC is very efficient and even more efficient than a Switched BEC [65].

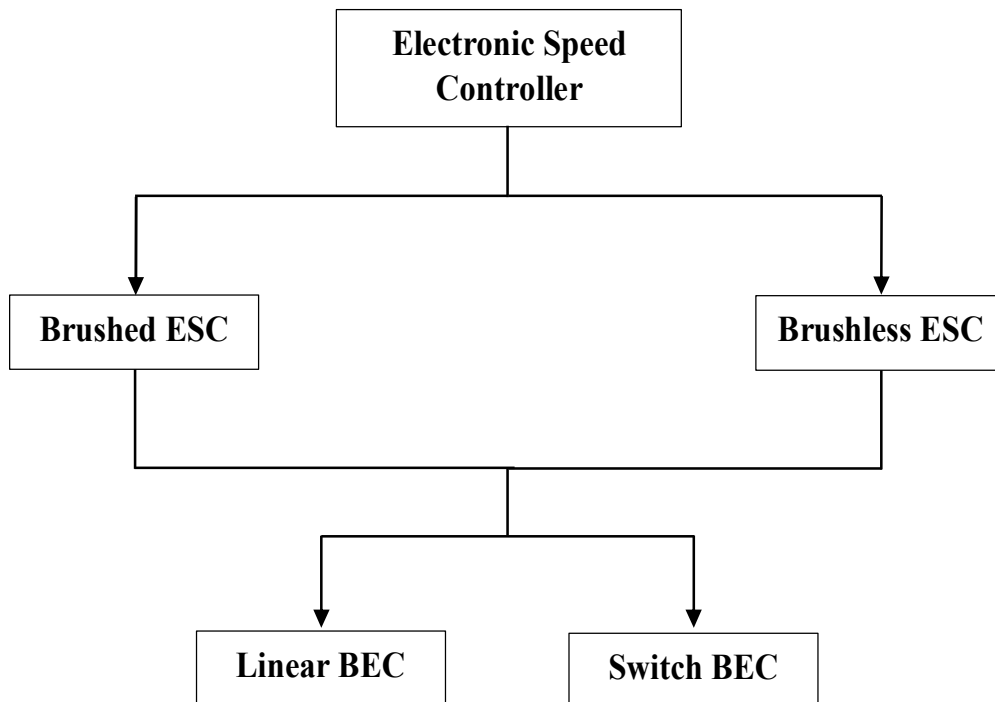

Fig. 16. Classification of ESC

3.5.4 Switched BEC (SBEC)

A switched BEC's function in the ESC is to convert a higher voltage into a lower voltage. Although the Linear BEC can perform this task as well however the Switch BEC can achieve a higher efficiency when the difference of input and output voltage is large [66]. Power is supplied to the output by turning on the MOSFET and then turning it off when a predetermined value output is reached. This operation is repeated rapidly and results in more efficiency and less heat generation than a LBEC. However there is always a trade-off. The switch BEC has a higher output noise and EMI/RFI emission as compared to the LBEC.

3.6 Transmitter and Receiver

A transmitter is used to transform human command into signals to a receiver in order to control the RC boat. Primitive operation of the transmitter essentially involves switching on and off the oscillating circuit. This results in a simple continuous wave or on/off keyed transmission. Parts of a modern transmitter consist of a reference oscillator or frequency source to generate alternating current, a modulator which modifies that oscillation to contain information, a power amplifier which amplifies the carrier wave to get higher power, and an antenna that turns the electrical signals into radio waves. For certain external components of a transmitter as its power supply and crystal which is used to tune the circuit is needed, but the basic structure of a transmitter remains the same [67]. The MHz and 2.4GHz transmitter can be classified by the antenna. Typically, a MHz transmitter has a collapsible aluminium antenna while the 2.4GHz has a shorter plastic antenna.

A receiver is in fact the opposite of a transmitter which is used to filter the antenna signal into a desired signal and amplify it to a higher power and feed it to the demodulator. The received frequency of the receiver can be varied in order to receive different frequencies from different channels. The signal level depends on the distance between the transmitter and receiver and therefore an amplifier is used to compensate the receive signal at various levels.

In earlier versions of the receiver, a radio frequency (RF) filter is used to filter the received signal before it is fed to the demodulator. However, there are many drawbacks such as limitations on transmission frequency magnitude,

a limited frequency range for constant bandwidth and high costs [58]. All of these disadvantages were however eliminated by the Superheterodyne receivers which replaced the use of RF filter with a mixer of variable local oscillator frequency.

Radio frequency is the oscillation rate between the range of 3 Hz to 300 GHz and this range corresponds to an alternating current electrical signal frequency [68]. Various radio frequencies are available for remote control, but only a few radio frequencies may be used for RC boat control to prevent serious issues due to frequency interference. The most common radio frequencies used in remote control boat are 27 MHz, 40 MHz and 2.4 GHz. Generally there is no difference between radio frequencies in MHz except the channel number. There are a total of 13 channels for 27MHz and 34 channels for 40MHz. The channels of the radio frequency can ALSO be changed by replacing another crystal. The 2.4 GHz set with the "digital spectrum modulation" technology overcame the frequency interference problem. There are two main broadcasting methods used by spread spectrum manufacturers which is FHSS (Frequency Hopping Spread Spectrum) and DSSS (Direct Sequence Spread Spectrum) [69], thereby no crystals are required for the 2.4GHz sets.

3.7 Servo Motors

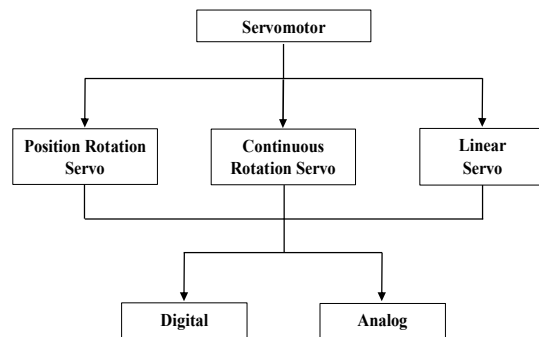

Fig. 17 Classification of Servomotor

A servomotor is an electrical device capable of pushing or rotating an object with great precision and is widely used to rotate an object at certain specific angles or distances [70]. In general, a servomotor consists of an electrical motor, gearbox, potentiometer, and an electronic circuit [71]. In the RC boat, a servomotor is linked to boat's rudder and is used to control the motion of the rudder. As illustrated in Fig. 17, a servomotor

can be classified into position rotation servo, continuous rotation servo and linear servo. All of these servomotors can then be further divided into a digital or analogue type of servomotor. The difference between these servomotors is discussed below.

Initially, there is no electrical signal generated at the output of the potentiometer. When an electrical signal is sent to another input terminal of the error detector amplifier, there is then a difference between the 2 signals. One signal comes from potentiometer while the other from other sources. This is then processed in the feedback mechanism and an output is provided in terms of an error signal. This error signal acts as the input for the motor, and causes the motor to begin rotating.

Given that the motor shaft is connected to the potentiometer, hence when the motor rotates; the potentiometer generates a signal. As the potentiometer's angular position changes, its output feedback signal as well, changes. After sometime, the position of the potentiometer reaches a position where the output of potentiometer is the same as the external signal provided. At this stage, there is no output signal being sent from the amplifier to the motor input as there is no difference between the external applied signal and the signal generated at potentiometer. What also then follows in such a situation is that the motor stops rotating.

Servos are driven by PWM signals and the pulse continuously streaming in at a period of 20ms. The angle the servo arm rotates depends on the duration of the pulse. When a pulse is lesser than 1.5 ms, servos rotate counter clockwise from the neutral point and hold at a certain degree. It is then the opposite for a pulse wider than 1.5 ms [72]. Typically, the minimum pulse required is 1ms and 2ms is the maximum pulse. However different manufacturers have different maximum and minimum pulses [73]. In general, servo motors can be classified into position rotation servo, continuous rotation servo and linear servo motor [74].

3.7.1 Position rotation servo

The most common type of servo motor is that which's output shaft rotates 180 degrees or in half a circle. A physical stops is placed within the gear mechanism to protect the rotational sensor from damage, and prevent rotations beyond its maximum limit [74]. Position Rotation Servo is

found in many applications such as radio control vehicles, unmanned aerial vehicles and several others.



Fig. 18. Position rotation servomotor



Fig. 19. Continuous rotation servomotor

3.7.2 Continuous rotation servo

The type of servo motor seen in Fig. 19 is largely correlated to the position rotation servo motor. But, continuous rotation servo motors can rotate in either directions indefinitely. Further, rather than setting the position of the motor, the control signal is interpreted as the rotation speed and direction.



Fig. 20. Linear servomotor

3.7.3 Linear servo

In essence, linear servo is similar to the servos discussed above. But additional gears are attached to modify the output from a circular motion to a back-and-forth motion. Be that as it may, these kind of servos are used in larger model airplanes as an actuator are therefore difficult to find. Typically, linear servos are applied in industrial machines that require high precision [75].

Servo may be further classified into analog servos and digital servos. In fact, both servos motor are quite similar, save for the way the signal processed from the receiver and how the information is then used to send power to the servo motor. Analog servos operate based on applying the on and off voltage signals or pulse to the motor. This on-off frequency is standardised to 50 cycles per second and no voltage is delivered to it whilst it is at rest. Faster motor speeds and a higher torque can be obtained when a longer “ON” pulse is being sent. However, analog servos are weak in producing torque for short pulses. Therefore their sensitivity is decreased and they are unable to respond to slight variations and greater dead-band voltage range for analog servos.

To overcome this problem digital servos use a small microprocessor to analyse the receiver signals and process these into high frequency voltage pulses to the servo motor. Instead of 50 pulses per second, digital servos are able to send 300 pulses per second [76]. The high frequency allows for faster response and more

constant torque. Thus the amount of dead-band is decreased and there a higher holding power is made available [77]. However, the drawbacks of a higher frequency are two-fold. First is a high power consumption. And second, is that digital servos come with a pricier tag.

3.8 Power Source

Although various power sources can be used to power a RC boat, but as mentioned earlier, this paper limits focus to battery powered sources. A battery is a device operated by converting chemical energy into electrical energy through an electrochemical discharge reaction. A battery is formed by one or more electrochemical cells, and the electrochemical cell is in turn composed of a cathode, anode and electrolyte.

Cells may be divided into two major classes: (i) primary and; (ii) secondary. Primary cells are not rechargeable. Once the reactants deplete, the cell must be replaced. Secondary cells on the other hand are rechargeable. Its reactants can be restored to a fully charged state via a DC charging source. Since the RC boat is considered a high-power consuming device, primary class batteries are therefore very rarely used as a main power supply for the RC boat. Secondary class batteries are more widely used in RC applications as they are more commercial. Various commonly used rechargeable batteries are as shown in Fig. 21. They are also individually examined and explained in detail below.

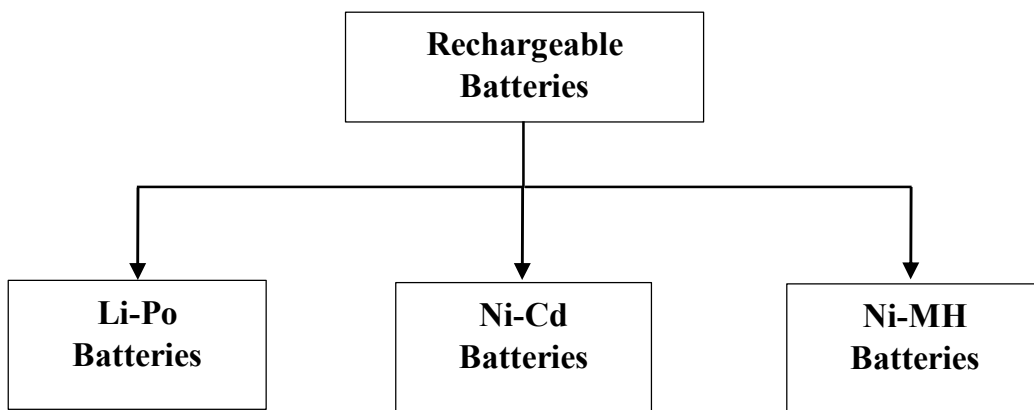

Fig. 21. Different types of rechargeable battery

3.8.1 Nickel cadmium batteries (Ni-Cd batteries)

Ni-Cd batteries are composed of nickel oxy-hydroxide (positive electrode), cadmium (negative electrode) and an alkali solution as the electrolyte [78]. The nominal voltage of Ni-Cd is 1.25V and the discharged voltage remains relatively constant until its capacity is discharged and the voltage then drop off sharply. However, the “memory effect” occurs when Ni-Cd batteries are overcharged at a higher temperature and subjected to many discharge cycles [79]. The Ni-Cd batteries then lose some of their capacity. However this effect can be prevented by limiting the number of charge and discharge cycles [80,81].

3.8.2 Nickel–metal hydride batteries (Ni-MH batteries)

Ni-MH batteries are formed by replacing the negative electrode of Ni-Cd batteries with hydrogen-absorbing alloy [82]. The discharge profiles and midpoint voltages of Ni-MH batteries are similar to Ni-Cd batteries. But the larger energy density characteristics allow Ni-MH cells to store 30% to 50% more energy per unit volume [83]. Ni-Cd batteries are able to withstand a wider temperature range and they do not suffer from the “memory effect”.

3.8.3 Lithium polymer batteries (Li-Po batteries)

Lithium polymer are one of the most advanced secondary batteries. They use a polymer electrolyte in gel or solid form, instead of liquid electrolyte. Generally, Li-Po batteries are packaged in plastic film as Li-Po has no free electrolytes. Therefore Li-po batteries have the advantage of occupying less space and are much lighter [84]. The energy density of Li-Po batteries is almost double compared to Ni-Cd and Ni-MH batteries. Thus the run time of a Li-Po battery is double for the same battery weight [85]. To add, Li-Po batteries also have the lowest self-discharging rate: which is about 5-10 % per month at a 20 °C surrounding temperature. Li-Po batteries as well do not suffer the “memory effect” that occur in Ni-MH and Ni-Cd batteries [86,87]. However, Li-Po batteries lack the ability to tolerate over-charge or over-discharges due to the nature of their lithium chemistries.

4. Basic Setup of a RC Boat

4.1 Material Selection

There are a wide variety of materials that have been used to build RC boats. These range from low strength materials such as wood to high strength materials such as steel. Each material serves its own purpose in relation to the application of the RC boat.

4.1.1 Wood

Wood is the most versatile building material among all other materials. Different wood have different properties [88–90]. Not only are the superficial characteristics of the wood such as their colour and texture of different, but they also have different stabilities, strengths and stiffnesses. Wood, although having a relatively low strength compared to metals or synthetic materials, are nevertheless easier to shape and bend without cracking. Complex shapes can be made using wood without exerting too much effort. Metal on the other hand can only be used to fabricate a hull with a simple design as it requires too much effort to be shaped into different complex shapes.



Fig. 22. RC boat hull made from wood [91]

4.1.2 Metal

Metal is one of the most commonly used materials in real sized boats. But in the wide family of RC boats, metal does not remain a top choice. Although metal has its with advantages such as a low relative cost, good fire resistance and can be easily repaired; but it however has more disadvantages that outweigh its advantages such as it corrodes easily, is heavy and magnetic [92–94]. Corrosion is an important aspect to considered in building a boat hull as the hull is in constant contact with water. Although protective coatings could be used to prevent corrosion, but this requires constant maintenance from time to time to prevent

corrosion. Once the metal begins to corrode, the owner then has to repair the hull or replace the entire hull.

Another commonly used material is aluminium alloy. Aluminium alloy has versatile properties owing to its unique combination of properties for engineering and construction purposes. Aluminium alloys have the advantage of light weight against steel, and some alloys may achieve greater strength than structural steel [95–99]. Thus, aluminium alloy provides better strength-to-weight ratio compared to steel. Aluminium alloys also have high corrosion resistance.



Fig. 23. RC boat hull made from metal [100]

4.1.3 Composites

Composite materials such as carbon fibre and fibreglass are the most commonly used materials insofar as RC model boats are concerned. The properties of a polymer composite are dependent on the properties of the reinforcing fibres, the resin material and the laminate arrangement used. This is one of the main selling points of composite material — it can be tailored for specific applications.

The advantages of composites over other materials are listed below [101–105]:

- Low magnetic properties
- Low electrical conductivity
- Resistance to corrosion
- Resistance to rot and marine growth
- Relatively high sonar transparency
- Good strength to weight ratio
- Good fatigue properties
- Stiffness and strength can be tailored to structural requirements
- Light weight
- Excellent thermal insulation



Fig. 24. RC boat hull made from fiberglass [106]

4.2 Vessel Resistance

When a solid body moves through fluids, it experiences opposing forces that prevent it from moving forward [107]. These forces act in opposition to the motion direction and are known as resistance or drag. Generally, a body travelling on the ground experiences only air resistance. A boat, a vessel that is used to travel on water however, experiences two resistances at the same time: water resistance, as well as air resistance. The lower part of the boat moves through water while the upper part through air. There is a major difference in density between these mediums. Due to the fact that air density is much smaller than compared to water density, the air resistance is also usually smaller than the water resistance. Planing a hull or a hull with superstructure such as catamarans requires foresight that it will experience a higher air resistance than any other type of hull due to its structure. This additional air resistance must be considered as it is the reason behind blow-over of such boats.

The resistance faced by a vessel moving through calm and free waters can be decomposed into components. One common way is to differentiate the resistance into a pressure resistance and a friction resistance. Another frequently used decomposition is dividing them into viscous resistance and wave resistance [108].

All practical fluids are viscous. Therefore, viscous resistance plays an important role in providing resistance not only in water but also in air. Viscous resistance arises due to shear forces when the vessel moves through surrounding waters and air. Viscous resistance by air usually

contributes only a minor part of the total resistance faced, but this is highly dependent on the aerodynamic properties of the vessel as well [109]. Wave resistance occurs due to the generation of water waves or water spray. The waves create a drag force onto the vessel. In other words, more intense waves cause more resistance to the vessel. The total resistance coefficient is a dimensionless quantity defined as:

$$C_T = \frac{R_{tot}}{\frac{1}{2} \rho U_{hull}^2 A_{w0}} \quad (1)$$

where R_{tot} is the total resistance (MLT^{-2}), ρ is the density of the water (ML^{-3}), U_{hull} is the hull speed (LT^{-1}) and A_{w0} is the wetted area at rest (L^2). This coefficient is used to characterize the total resistance and to compare the performance of the different hulls. Wave drag or wave resistance may be expressed in the dimensionless ratio of the Froude number [110]. When the vessel is operating on a calm water surface, the drag is defined as:

$$Drag_{wave} = 16.778 \times Fn^{7.164} \times g \times \Delta \quad (2)$$

where g is the gravitational acceleration of $9.81m/s^2$ and Δ is the loaded mass of the ship in kilograms. The drag calculated is in a unit of newton. Additional wave drags occur when there are other waves present on the water surface and bash onto the vessel. For rough and choppy waters, the added wave drag is approximated as:

$$Drag_{wave,Added} = 0.000485 \times \left(\frac{L}{(V_{DISP})^{\frac{1}{3}}} \right)^{1.89} \times g \times \Delta \quad (3)$$

where L is the waterline length of the hull in meters, V_{DISP} is the volume of water displaced by the hull in cubic meters, g is the gravitational acceleration of $9.81m/s^2$ and Δ is the loaded mass of the ship in kilograms. Viscous drag or viscous resistance can be expressed as:

$$Drag_{Hull} = \frac{1}{2} \rho_{water} V^2 A_W C_F \quad (4)$$

where ρ_{water} is the density of water which is 1000kg per cubic meter, V is the speed of the boat in meters per second, A_W is the wetted area in meters squared and C_F is the skin friction coefficient where $C_F = 0.005$ for model boat sizes.

4.3 Wave Pattern

When an object moves through a calm water surface, it induces a wake pattern that is also known as the Kelvin wake pattern as illustrated in Figure 25. The intensity of the waves reflect the amount of energy emitted by the object onto the water surface [111,112]. The angle between the object's trajectory and the wave fronts—or that is also known as the Kelvin angle—has been proven to be around 19.7° irrespective of the speed of the object [113]. The speed of the entire pattern is the same as the object movement speed. In fact, it appears to be that it was attached to the object.

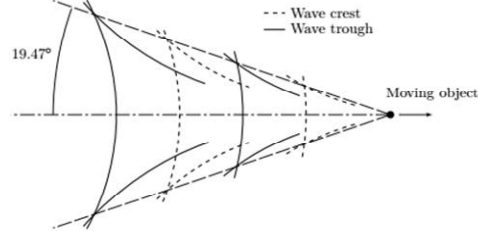

Fig. 25 Kelvin wake pattern [113]

4.4 Lift Force

Planning a hull requires the lift force to allow the vessel to plan over the water surface. The lift force consists of two terms: (i) the hydrodynamic term and; (ii) the hydrostatic term [114]. Lift coefficient based on the beam squared is denoted as $C_{L,b}$ whilst lift coefficient based on the bottom area is denoted by $C_{L,s}$. These coefficients may be obtained through equations (2) and (3).

$$C_{L,b} = \frac{L}{0.5 \rho V^2 b^2} \quad (5)$$

$$C_{L,s} = \frac{L}{0.5 \rho V^2 b^2 \lambda} \quad (6)$$

where L is the lift force in $kgms^{-2}$, ρ is the density of the water in kgm^{-3} , V is the forward moving velocity in ms^{-1} , b is the beam in m and λ is the non-dimensional mean wetted length given by:

$$\lambda = \frac{L_M}{b} \quad (7)$$

where L_M is the mean wetted length in m.

4.5 Design Ratios

4.5.1 Speed-length ratio

Speed-length ratio is one of the most important ratios in designing a boat. Speed-length ratio is the speed of the vessel in knots divided by the square root of the vessel's waterline length in feet [115]. It is also known as "hull speed". At a speed-length ratio of less than 1.34, the vessel is in a displacement-mode motion which means the vessel is simply pushing out water as it moves forward. When the speed ratio exceed 1.34 but lower than 2.5, the vessel is in a semi-displacement mode. It is attempting to rise up over its own bow to get onto plane. With the speed-length ratio above 2.0 to 2.5, the vessel is planing and it relies on the lift force to raise and hold it out of the water. Speed-length ratio can be calculated through various equations.

The length of a free-running wave on sea is given as below:

$$L = 2\pi \frac{V^2}{g} \quad (8)$$

where π equals to 3.14159, V is the wave speed in feet/second and g is the gravitational acceleration. If the constants are moved to the left side of the equation and the variables are put to the right side and it is converted to rid of the speed squared:

$$\left(\frac{\pi}{2}\right)^{\frac{1}{2}} = 0.39894 = \frac{V}{(gL)^{\frac{1}{2}}} \quad (9)$$

where $\frac{V}{(gL)^{\frac{1}{2}}}$ is Froude number, F_n , a dimensionless ratio. Through an experiment conducted, it was found that when L_{wl} , the length of the waterline on the boat, equalled to L , the length of a free-running wave, boat resistance increased drastically. The wave generated is as long as the boat. And if the boat tries to go any faster, the length of the wave will be longer than itself, and this requires a tremendous amount of added energy. If the Froude number is converted such as that the speed is in knots and gravitational acceleration is put over to the right side of the equation, the following is obtained:

$$\frac{V}{L_{wl}^{\frac{1}{2}}} = g^{\frac{1}{2}} (0.39384) \left(\frac{3600}{6076}\right) = 1.34 \quad (10)$$

and because of this conversion, the speed-length ratio is not dimensionless. Therefore when the speed-length ratio equals to 1.34, the length of the boat's wave is as long as the boat's waterline length.

4.5.2 Displacement-length ratio

Displacement-length ratio, in short DLR, is a commonly used ratio for comparing designs and estimating speed [116]. DLR can be defined as:

$$DLR = \frac{Displacement}{\left(\frac{L_{wl}}{100}\right)^3} \quad (11)$$

where Displacement is in long tons and L_{wl} is in feet. A long tons is 2,240 pounds. Larsson/Eliasson's *Principle of Yacht Design* uses the inverse of this concept in Length-Displacement Ratio, LDR (i.e. refer to equation 12). This is length in meters divided by the cube root of volume of displacement in cubic meters, a true dimensionless ratio.

$$LDR = \frac{L_{wl}}{\sqrt[3]{Volume}} \quad (12)$$

A boat with high DLR tends to move slower than a boat with low DLR under the same power, sail area and wind power.

4.6 Electrical and Electronic Component setup

Propeller thrust is affected by the diameter of propeller, amount of acceleration and medium density. Therefore according to momentum considerations, it can be expressed as shown in Equation 13 as below (54):

$$T = \frac{\pi}{4} \cdot D^2 \cdot \left(v + \frac{\Delta v}{2} \right) \cdot \rho \cdot \Delta v \quad (13)$$

where T is Thrust in newton, D is Propeller Diameter in metre, v is Velocity of incoming flow in metre per second, Δv is additional velocity acceleration by propeller in metre per second, ρ is Density of the fluid kilogram per cubic metre.

The efficiency of the propeller is affected by the diameter of the propeller as previously discussed. If the diameter of propeller is too small, the thrust

generated will be insufficient to move the boat forward. Therefore, the minimum diameter of propeller has to be determined by the minimum diameter formula which can be expressed as shown in Equation 14 as below:

$$D_{min} = 4.07 x (BWL x H_d)^{0.5} \quad (14)$$

where

D_{min} is Minimum acceptable propeller diameter in inches
 BWL is beam on the waterline in feet,
 H_d is draft of hull from the waterline down in feet

The effect of the optimum pitch diameter ratio is truly important in boat building. Thus, it must be determined carefully at the initial design stage. For example, high speed vessels ought to have a larger pitch diameter ratio than the optimum value to obtain an optimum efficiency [117]. The pitch diameter ratio can be determined by Equation 15, 16 and 17 which are expressed as below:

$$\text{Average Pitch diameter ratio} \quad (15)$$

$$= 0.46 x Knts^{0.26}$$

$$\text{Maximum Pitch diameter ratio} \quad (16)$$

$$= 0.52 x Knts^{0.26}$$

$$\text{Minimum Pitch diameter ratio} \quad (17)$$

$$= 0.39 x Knts^{0.26}$$

Common practice entails that a rudder be installed in line with the propeller whereby the high-energy slipstreams of the propeller is faced to approach better boat manoeuvrability [118] with an optimum longitudinal separation (X) which is in the range of 0.30-0.35 percentage of diameter of the propeller [49]. The Rudder should be installed to turn about 35 degrees but not over 40 degrees from the centre to both directions to prevent stalling, immediate loss of control. Otherwise the strain on the rudder which increases drastically may damage the rudder (48). For rudders working in line to a propeller, an approximate minimum total area of the rudder can be determined by Equation 18 which expressed as shown below:

$$A = \frac{TL}{100} \left[1 + 50 C_B^2 \left(\frac{B^2}{L} \right) \right] \quad (18)$$

where, A is total rudder area in square metre, L is ship length in metre, B is ship breadth in metre,

T is ship draught in metre,
 C_B is block coefficient $\left(\frac{\nabla}{LBT} \right)$

Rudders being very thin objects may be treated as a thin foil to allow the 'aerohydrodynamic' theory to be applied. This means that the forces acting on the rudder due to the fluids flowing around it can be simplified into lift force and drag force acting in a center of effort [119]. The lift force acts perpendicular to the apparent fluid whist the drag force acts co-linear to it and both of them may be expressed as Equation 19 and Equation 20 as shown below:

$$L = \frac{1}{2} \rho A v_a^2 C_L \quad (19)$$

$$D = \frac{1}{2} \rho A v_a^2 C_D \quad (20)$$

where ρ is the density of the flowing fluid in kilogram per cubic metre, A is the plane area of the foil in square metre, v_a is the mediums apparent velocity in metre per second, C_L and C_D are lift and drag coefficient respectively. These coefficients depend on the medium's angle of attack, α and the foil's shape. The lift and drag coefficient can be approximated using Equation 21 and 22 which are expressed as below:

$$C_L = k_1 \sin(2\alpha) \quad (21)$$

$$C_D = k_1(1 - \cos(2\alpha)) \quad (22)$$

where k_1 is a constant. This means that the lift and drag force may be combined into one single force, g in newton, acting perpendicular to the rudder which can be expressed as shown in Equation 23 below:

$$\begin{aligned} g &= L \cos(\alpha) + D \sin(\alpha) \\ &= k \frac{1}{2} v_a^2 \{ \sin(\alpha) \cos(\alpha) \\ &\quad + [1 - \cos(\alpha)] \sin(\alpha) \} \\ &= k v_a^2 \sin(\alpha) \end{aligned} \quad (23)$$

where, $k = k_1 \rho A$. The apparent velocity of the water near the rudder is assumed to be parallel to the boat heading, assuming that there are no currents or vortexes produced by the hull that affect the rudder. The angle of attack is given as $\alpha_r = -\delta_r$, where δ_r is the angle of rudder. The apparent velocity becomes equal to the boat velocity. The force acting on the rudder can be calculated by Equation 24 which can be expressed as below:

$$g_r = -p_5 v^2 \sin(\delta_r) \quad (24)$$

where, p_5 is lift coefficient of rudder.

The motor selection process begins with evaluating the application and ensuring that the motor chosen sufficiently meets the needs of the application. Designers ought to ensure that the input power source does not exceed the maximum current and voltage allowed to prevent the motor from bursting. KV ratings are the main criteria in motor selection. This means that the no-load rotational velocity of the motor is per 1 V input. A motor labelled with 2000 KV means that the motor will rotate in 2000 RPM when 1 Volt was supplied and 4000 RPM for 2 volts supplied. The torque of the motor can be expressed as shown in Equation 25 below:

$$T = \frac{5252 \cdot Hp}{Rpm} \quad (25)$$

where Hp is horsepower, Rpm is revolution per minute

Similar to the motor selection, the maximum voltage allowed for the servo must be identified to protect the servo motor from damage. The torque and speed are the main criteria in selecting the servo. Essentially, the speed of motor is labelled in unit second per degree which can be defined as the time needed in a second to reach the desired degree. To select a suitable servo, the load on the servo must be predetermined before the servo is selected.

Generally, the capacity is labelled in unit of mAh (miliamp-hours), which is a metric used to indicate the time the battery can last. The approximate runtime can be calculated by dividing the amount of current going to drawing which can be expressed as Equation 26 as shown below [120]:

$$\frac{capacity}{1000} \cdot \frac{1}{I_{max}} \cdot \frac{60}{1} \approx T \quad (26)$$

where, I_{max} is maximum current in ampere and T is runtime in min

The C-Rating is an indicator of the continuous discharge rate. To determine the maximum continuous discharging rate the battery is capable of withstanding, multiply the C-rating with the capacity. For example, if a battery has a capacity of 2000 mAh and a discharge of 25C, then the maximum continuous discharge is:

$$\frac{Capacity}{1000} \cdot C - rating \approx 50A \quad (27)$$

This means that the example battery can discharge at 50A without damaging itself.

5. POTENTIAL APPLICATION OF BATTERY-POWERED RC BOAT

RC boats, after many years of innovation, have been modified to adapt to various applications. A basic RC boat can only be used to travel along water surfaces without serving any useful purpose. But by attaching different parts and equipment, a RC boat can be used to serve many other purposes. Various applications of the RC boat can be seen in the flowchart below.

5.1 Hobby

One of the most common application of the RC boat is as a hobby. Most casual hobbyists enjoy to steer their RC boat freely on ponds or lakes. In most cases, they do not compete for speed. They solely enjoy to plane the boat across the water surface. Sometimes, they also perform some complex tricks using their RC boat. Apart from operating the boat on water, some enjoy building the RC boat's hull. Those with carpentry skills enjoy building their own RC boat from scratch. From building RC boat from scratch to running it across water, RC boats provide hours of indoor and outdoor entertainment.

5.2 Racing

For some advanced users that are also addicted to speed, they use their RC boats to race. There are two main categories of RC boat racing. Racing sailboats is the racing of radio-controlled yachts. They are governed by World Sailing (WS) and are subject to the rules and regulations for racing introduced by WS. The racing rules of sailing is similar to the rules for full-sized crewed sailing boats, but with additional rules pertaining to the controller. Another type of RC boat racing is the racing of power boats. There are two organisations that oversee RC boat races. One is North American Model Boat Association also known as NAMBA and the other is the International Model Power Boat Association also known as IMPBA [121]. They provide the rules and standards that are used in these races. Before joining any race, one must first register under one of these organisations. The rules and standards for both organisations are similar. But, they are nevertheless some subtle differences that must be taken into account before deciding which to join.

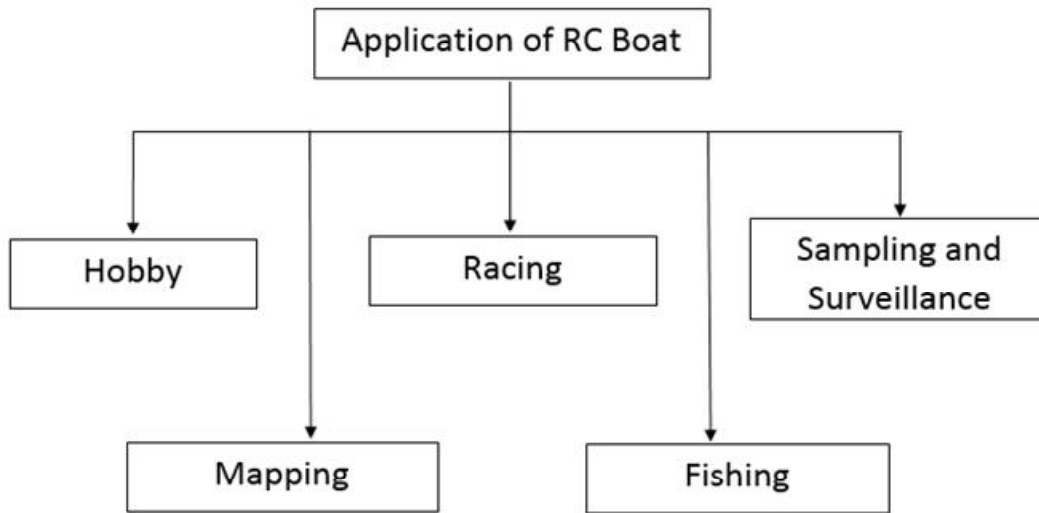

Fig. 26. Flowchart showing various applications of battery-powered RC boat

One cannot simply join any race with a random boat. Each organisation has a list of boating information for specific boat classes. These boats are differentiated into a few different classes depending on several criteria. Racing RC boats are mainly differentiated by the types of power they use. Boats using sail, gas and electric are grouped separately to prevent unfairness. The most popular power choice over the years has been gas due to the speed it provides. However, electric boats have also been rising in popularity recently as they get faster in line with technological growth. Further, the different types of hulls are also one of the criteria for determining which class a boat belongs to. The two main types of hull are mono hulls and hydro hulls. Engine sizes are also one of the criteria to determine the class of a boat.



Fig. 27. RC boat racing [121]

5.3 Sampling and Surveillance

Sampling and surveillance have never been an easy task especially when it comes to the ocean. Over the past decades, the oceanographic community has begun relying on robotics and automated devices to collect data. Recently, the utilization of state of the art technologies such as autonomous underwater vehicles, underwater profilers and unmanned surface vehicles have increased exponentially [122,123]. This not only eases the work of collect samples and data from the ocean, but the data collected also allows for a better understanding of ocean dynamics and broadens the knowledge available to mankind. This has in turn allowed for the development of various mathematical models that can replicate the actual conditions of the ocean.

Coastal management authorities can also benefit from the technology advancement in RC boating. Authorities are exposed to great risks whilst fighting illegal activities, in particular trading and emigration. Utilising RC boats in this field could greatly reduce the risk of harm and surveillance can be done remotely from a safe distance. Unmanned vehicles equipped with action cameras could be used to spy on suspicious ships before approaching them cluelessly which may cause harm to the authorities.

5.4 Mapping

Bathymetry mapping of ponds, lakes and rivers has been a challenge using traditional methods. Techniques used were either low in spatial resolution, subjective in terms of precision and accuracy, labour-intensive or required a high level of safety precautions [124,125]. Old techniques require a large amount of resources and in return, they do not produce any promising results either.

Sonar devices equipped with GPS technology also known as fish finders are not something new to the world. They have been widely used by those in the boating community. By combining the GPS technology with sonar: the location and depth can be recorded electronically onto any memory system. The working principle behind the fish finders is rather simple. Sonar system transmitters send a signal and it then reflects back after hitting an object. The reflected waves are then received through a receiver and recorded. In order to prevent confusion and false signals, the waves coming after reflected by fishes and any other objects are displayed differently [126–129]. Water depth and GPS coordinates are recorded from the sonar system. Next, the map coordinates are convert into Universal Transverse Mercator (UTM). A

complete bathymetry map, as displayed in Fig. 28, is done after filtering and gridding.

Introduction of GPS-sonar equipped remote control boat is a timely blessing to the industry. Applying GPS-sonar system to a remote control boat can minimize the physical work force required to map a certain pond or lake. Traditional techniques may require several persons to perform, but it only one person is required to control a remote control boat. A small RC boat can maneuver across the water surface freely while collecting data from the base.

5.5 Fishing

Apart from all the technical usage of RC boats, they can also be used for fishing or baiting. Some like to fish and at the same time, they also fancy handling RC boats. Hence, combining these two hobbies together could elevate the fun. Fishing fans usually use many different ways to cast bait such as casting, boating and hand releasing. All of these methods share common cons such as a short range, inaccuracy, inconvenient and dangerous [130]. With the aid of RC boat, all these problem can be solved immediately. RC boats can be controlled remotely from a distance and the location of the bait be accurately placed by controlling the RC boat's direction and speed.

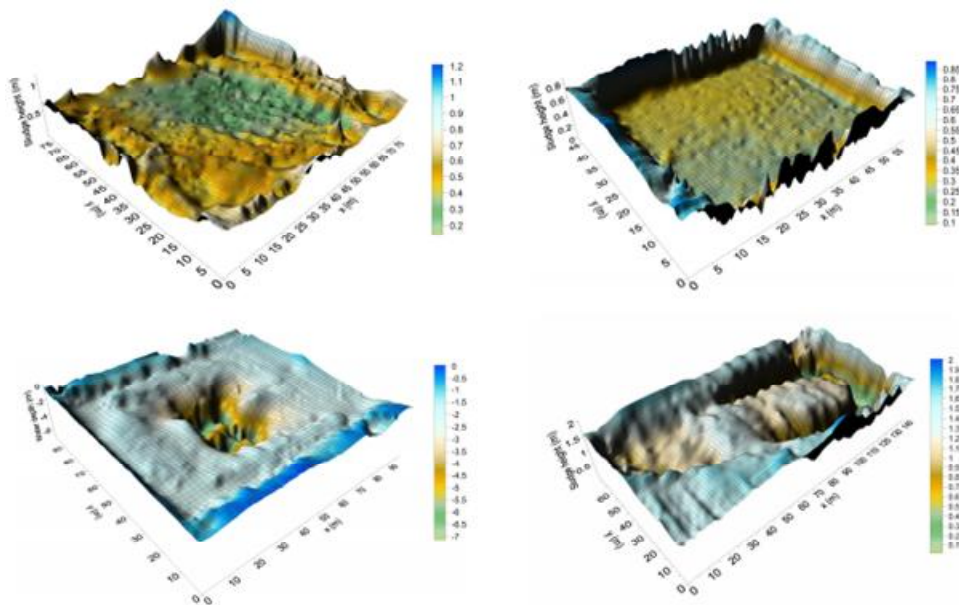

Fig. 28. Sample bathymetry maps from different ponds [124]

Essentially, all RC boats could become fishing vessels by simply attaching a line, hook and bait. There are also however some RC boats that are made specifically for fishing. These dedicated RC boats have many equipments installed that help the user fish, such as the sonar fish finder, water temperature detection system and fish-tempting light. Unlike in racing, electric-powered RC boats are more preferred in fishing. Five main factors that made electric-powered RC boats work better are that they are quieter on water, use almost zero power when idle, do not rely on oxygen to run, are easier to maintain and have better agility. The electric motor also does not produce as much noise as gasoline-powered motors, hence it is quieter. The electric motor also can be turned off when not in used without the motor continuously running.

Fishing via the RC boat is considerably simple. The user simply has to attach the fishing line from the fishing pole to the boat with hook and bait. Then, he has to open the bail on the rod. Next, steer the RC boat to the desired location and release the line. The boat is then brought back in and when there is fish on the hook, the user can simply reel in the fish with the fishing rod [131]. When the RC boat is kept on the water, it is however very risky as large fish may cause damage to the boat or even swim off with the vessel. Thus, most fishing RC boats are equipped with a line disconnection mechanism.

Once a fish is hooked, the line is disconnected and the user becomes free to reel in the fish.



Fig. 29. RC boat designed for baiting [130]

6. PRICING

RC boats have become one of the most popular RC devices available in the market. RC boats can be commonly found in RC dealerships or through online websites. The table 1 below shows the price range of the different type of hulls. The materials, maximum speed range, availability, scale and weight range are also shown in the table 1. Availability indicates the ease of obtaining a specific hull from the market.

Table 1. Price range of different type of hulls

Type of hull	Full Body Hydroplane	Outrigger Hydroplane	Monohull	Catamarans	Tunnel Hull
Price Range (RM)	450 – 2600	420 – 10500	45 – 4135	450 - 7500	300 – 1350
Material	ABS, PA, PC, Epoxy Fiberglass	Laminated plywood, Ultra-strong Coated Wood, Epoxy Fiberglass, Epoxy Resin Layup	ABS, Fiberglass	ABS, Fiberglass	Fiberglass, Epoxy Resin, Wood, Carbon Fibre
Max Speed (km/h)	50 – 130	30 - 140	25 – 80	40 - 80	45 - 80
Availability	Low	Low	High	High	Low
Scale	1/8 – 1/5	1/4, 1/8	1/4, 1/8, 1/10	1/8, 1/10	1/4, 1/8, 1/10
Weight (kg)	1 - 2.3	0.23 – 12	0.8 - 2.8	2.1 - 9.2	1.25 – 1.8

Remark: ABS - Acrylonitrile butadiene styrene; PA -Polyamide; PC - Polycarbonate;
 Source: All information retrieved from- www.amazon.com and www.aliexpress.com

6. CONCLUSION

Finally it can be concluded that RC boats have become one of the most popular RC devices available in the market in terms of pricing. The various applications of RC boat includes hobby, fishing with GPS located devise, bathymetrical information gathering, sea-bed or river bed mapping with sonar technology, racing etc. There are various usage of RC boat in different sectors and the paper highlights an overview of the RC boat's basic components and its setup. Owing to the review works presented, future research is proposed which may open new research pathways to the subject of interest.

ACKNOWLEDGEMENT

The authors would like to thank Dr. Lim Wee Kuan and Ms. Pang Shen Yee for their valuable comments and efforts contributed to the realization of the current write-up.

COMPETING INTERESTS

Authors have declared that no competing interests exist.

REFERENCES

1. Williams M. What Percent Of Earth is Water? 23 April. 2014;(2, December):1.
2. Klouda N, Fauske G, Fliss M. Boat and Ship Building. 2018;1–39.
3. NSW. Big Ships, Small Boats. 2018. p. 1–2.
4. Coast T. Introduction to RC Scale Model Boating Model Shipbuilding - RC Overview. 2018;1–8.
5. Ellingson SW. Radio Systems Engineering. Cambridge Univ Press. 2016;16–7.
6. Van Arsdale AP. Homo erectus - A bigger, smarter, faster hominin lineage. Nat Educ Knowl. 2013;4(1):1–12.
7. Dunkley M, Stamper P. Ships and Boats : Prehistory to Present. Des Sel Guid. 2015;(April).
8. McGrail S. Boats of the World. 2001. 11 p.
9. McGrail S. Boats of the World: From the Stone Age to Medieval Times. 2004. 50-51 p.
10. Lawler A. Report of Oldest Boat Hints at Early Trade Routes. Science (80-). 2002;296(5574):1791–2.
11. M. Smith C, F. Haslett J. Construction and Sailing Characteristic of a Pre-Columbian Raft Replica. Bull Primit Technol. 1999;13–8.
12. Marincic A, Budimir D. Tesla ' s Multi-frequency Wireless Radio Controlled Vessel. :2–5.
13. Tesla N. Method of and apparatus for controlling mechanism of moving vessels or vehicles. Google Patents. 1898;(68):1–9.
14. Marincic A, Budimir D. Tesla's multi-frequency wireless radio controlled vessel. IEEE Hist Telecommun Conf HISTELCON 2008. 2008;
15. Adams JM. A Beginner's Manual for Outboard Hydroplane Racing. 2014. p. 1–39.
16. D. Swenson A. Hydroplane capable of making stable turns at high speeds. Google Patents. 1966;1–8.
17. Suwasono B, Akbar HMA, Sahir A, Munazid A. Outrigger RC Boat Model Hull Development As A High Speed Craft Based On Resistance and Lift Force. Procedia Eng. 2017;194:197–202.
18. Shun Sheng L. A STUDY OF THE RAFT, OUTRIGGER, DOUBLE AND THE DECK CANOES OF ANCIENT CHINA, THE PACIFIC AND THE INDIAN OCEAN. 1970. 1-237 p.
19. Hornell J. Water Transport: Origins and Early Evolution. 1973;1-307.
20. Texas EDJ. Outrigger Ages. J Polyn Soc. 1974;83(2):130–40.
21. McGrail S. Early Ships and Seafaring: Water Transport Beyond Europe. 2015;1-220.
22. Suwasono B, Akbar HMA, Sahir A, Munazid A. Outrigger RC Boat Model Hull Development As A High Speed Craft Based On Resistance and Lift Force. Procedia Eng. 2017;194:197–202.
23. Howard J, j. Doane C. Handbook of Offshore Cruising. 2000;1-352.
24. Mohammad H Bin. Remote Control Powerboat II (Boat Construction and Engine Installation). 2004;1–82.
25. Tuck EO, Lazauskas L. Optimum Hull Spacing of a Family of Multihulls. 1998;1–38.
26. Le Sueur G. Multihull Seamanship. 2018;1-148.
27. Dubrovsky VA, Lyakhovitsky AG. Multi-Hull

- Ships. 2001;1-495.
28. Yang C, Lohner R, Soto O. Optimization of a Wave Cancellation Multihull Ship Using CFD Tools. Proc Eighth Int Symp Pract Des Ships Other Float Struct. 2001;1:43–50.
 29. Misra SC. Design Principles of Ships and Marine Structures. 2015;1-474.
 30. Berman P, Scott B. Catamaran Sailing: From Start to Finish. 1999;11-219p.
 31. Watson DGM. Practical Ship Design Volume 1. 1998;1-558.
 32. Danielson C. Displacement Hull Catamaran Letter of Transmittal. 2006;1–95.
 33. D. Russell J. Secrets of Tunnel Boat Design. 2006;1-211.
 34. Condit R. Brushed DC Motor Fundamentals. Technology; 2010.
 35. Zeng S. Adaptive speed control design for brushed permanent magnet DC motor based on worst-case analysis approach. Math Probl Eng. 2013;2013.
 36. Hameyer K, Belmans RJM, Member S. Permanent Magnet Brushed DC Motors. 1996;43(2).
 37. Harrington AM, Kroninger C. Characterization of Small DC Brushed and Brushless Motors. Arl-Tr-6389 [Internet]. 2013;(March):1–48. Available: <https://www.google.dk/url?sa=t&rct=j&q=&esrc=s&source=web&cd=2&cad=rja&uact=8&ved=0ahUKEwiBq8fs6NrSAhUF3CwKHXxxBtIQFggiMAE&url=http%3A%2F%2Fwww.dtic.mil%2Fget-tr-doc%2Fpdf%3FAD%3DADA577582&usq=AFQjCNFdRmsUlgHA9IkVaoiimdz83XfpOQ&sig2=aBKSiB-D1Kd-R9VkvexFkg>
 38. Gamazo-Real JC, Vázquez-Sánchez E, Gómez-Gil J. Position and speed control of brushless dc motors using sensorless techniques and application trends. Sensors. 2010;10(7):6901–47.
 39. Yahya IR, Purwadi A, Haroen Y, Heryana N. Electric motor control and Battery Management System of Cikal Cakrawala ITB electric vehicle. 2012 Int Conf Power Eng Renew Energy, ICPERE 2012. 2012;(July):1–7.
 40. Yedamale P. Brushless DC (BLDC) Motor Fundamentals. 2003.
 41. Tasif TH, Karim MM. Effect of fish wedge on the hydrodynamic characteristics of a marine rudder. Procedia Eng. 2017; 194(September):136–43.
 42. Liu J. Impacts of Rudders on the Performance of a Benchmark Inland Vessel in the Rhine; 2018.
 43. Hou L, Wang C, Chang X, Huang S. Hydrodynamic performance analysis of propeller-rudder system with the rudder parameters changing. J Mar Sci Appl. 2013;12(4):406–12.
 44. Anthony Molland ST. Marine Rudders and Control Surfaces; Principles, Data, Design and Applications. 1st Editio; 2007.
 45. Kim HJ, Kim SH, Oh JK, Seo DW. A proposal on standard rudder device design procedure by investigation of rudder design process at major Korean shipyards. J Mar Sci Technol. 2012;20(4):450–8.
 46. Whicker, LF. Fehlner L. free-stream characteristics of a family of low-aspect-ratio, all-movable control surfaces for application to ship design; 1958.
 47. H T. Design of ship rudders; 1965.
 48. Degu YM. Redesigning the Rudder for Nigat Boat. 2014;1–9.
 49. Liu J, Hekkenberg R. Sixty years of research on ship rudders: effects of design choices on rudder performance. Ships Offshore Struct [Internet]. 2017;12(4):495–512. Available: <http://dx.doi.org/10.1080/17445302.2016.1178205>
 50. Liu J, Quadvlieg F, Hekkenberg R. Impacts of rudder profiles on ship manoeuvrability; 2015.
 51. Meng F, Zhang C, Zhao Y. Modeling and simulation of marine propeller load. 2016 IEEE Int Conf Mechatronics Autom IEEE ICMA 2016. 2016;0(5):2371–5.
 52. CAT. Marine Analyst Service Handbook. 4th Editio. 2001.
 53. Evinrude J. Propeller Selection Guide. 2012.
 54. AslamShaikh. Study of propeller design parameters.
 55. Techet AH. 13.012 Hydrodynamics for Ocean Engineers Marine Propellers. 13012 Hydrodyn Ocean Eng. 2004;1–20.
 56. Gatete E, Ndiritu HM, Kiplimo R. A Review on Marine Propeller Performance of High Speed Boat Running on an Outboard Engine. 2018;213–20.
 57. Kiam Beng Yeo, Wai Heng Choong WYH.

- Wageningen-B Marine Propeller Performance Characterization Through CFD. 2014;6.
58. Ulrich Tietze, Christoph Schenk, Ch Schenk EG. *Electronic Circuits: Handbook for Design and Application*. 2, illustr ed. Ulrich Tietze CS, editor. 2008.
 59. Gerr D. *The Propeller Handbook*. 2001. p. 50.
 60. Gong A, Verstraete D. Experimental Testing of Electronic Speed Controllers for UAVs. 53rd AIAA/SAE/ASEE Jt Propuls Conf [Internet]. 2017;(July). Available:<https://arc.aiaa.org/doi/10.2514/6.2017-4955>
 61. Brushed DC motor control using the LPC2101. *ReVision*. 2007.
 62. Green CR. Modeling and Test of the Efficiency of Electronic Speed. 2015;(September).
 63. Simpson C. *Linear and Switching Voltage Regulator Fundamentals part 1*. 2011.
 64. Brown M. *Power Supply Cookbook*. 1994.
 65. Zhang HJ. *Basic Concepts of Linear Regulator and Switching Mode Power Supplies*. 2013.
 66. Huffman B. *Efficiency and Power Characteristics of Switching Regulator Circuits*. Linear Technology. 1991.
 67. Stoehr MD. *RF Basics*. Martin D. Stoehr. 2012.
 68. Suhas S, Jayshri Z. Remotely Controlled Robotic Boat. 2017;(February).
 69. B.P.Lathi. *Modern Digital and Analog Communication System*. third edit. 1998.
 70. Pinckney N. Pulse-width modulation for microcontroller servo control. *IEEE Potentials*. 2006;25(1):27–9.
 71. Behnke S, Schreiber M. Digital Position Control for Analog Servos. *Work Humanoid Soccer Robot IEEE-RAS Int Conf Humanoid Robot* [Internet]. 2006; Available:http://www.ais.uni-bonn.de/nimbro/papers/HSR06_Control.pdf
 72. Papoutsidakis M, Chatzopoulos A, Symeonaki E, Tseles D. Methodology of PID Control – A Case Study for Servomotors. *Int J Comput Appl*. 2018;179(30):30–3.
 73. Incorporated CT, Technologies C, Technologies C. *RC Servo C36R, C40R, C55R*; 2009.
 74. Sadun AS, Jalani J, Sukor JA. A comparative study on the position control method of dc servo motor with position feedback by using arduino. *ARNP J Eng Appl Sci*. 2016;11(18):10954–8.
 75. Zheng J, Wang H, Man Z, Jin J, Fu M. Robust Motion Control of a Linear Motor Positioner Using Fast Nonsingular Terminal Sliding Mode. *IEEE/ASME Trans Mechatronics*. 2015;20(4):1743–52.
 76. Ross R. Investigation into soft-start techniques for driving servos. *Mechatronics* [Internet]. 2014;24(2):79–86. DOI:<http://dx.doi.org/10.1016/j.mechatronics.2013.11.014>
 77. Futaba. *Futaba Digital FET Servos*; 2000.
 78. Noréus D. Substitution of rechargeable NiCd batteries A background document to evaluate the possibilities of finding alternatives to NiCd batteries *Content*. 2000;36. Available:<http://ec.europa.eu/environment/waste/studies/batteries/nicd.pdf>
 79. Zahran M, Atef A. Electrical and Thermal Properties of NiCd Battery for Low Earth Orbit Satellite 's Applications. 2006;(January):122–30.
 80. Kularatna N. Rechargeable batteries and their management: Part 30 in a series of tutorials on instrumentation and measurement. *IEEE Instrum Meas Mag*. 2011;14(2):20–33.
 81. Shukla AK, Venugopalan S, Hariprakash B. Nickel-based rechargeable batteries. *J Power Sources*. 2001;100(1–2):125–48.
 82. Cabral M, Margarido F, Nogueira CA. Characterization of Spent Ni-MH Batteries. *Mater Sci Forum* [Internet]. 2012;730–732(January):569–74. Available:<https://www.scientific.net/MSF.730-732.569>
 83. Philips Semiconductor Ltd. Application note NiMH and NiCd battery management. 1995;19(3):165–74.
 84. Murata K, Izuchi S, Yoshihisa Y. Overview of the research and development of solid polymer electrolyte batteries. *Electrochim Acta*. 2000;45(8):1501–8.
 85. Simpson C. *Characteristics of Rechargeable Batteries Literature Number: SNVA533*. 2011.
 86. Deng D. Li-ion batteries: Basics, progress, and challenges. *Energy Sci Eng*. 2015;3(5):385–418.

87. Cherkashinin G, Hausbrand R, Jaegermann W. Performance of Li-Ion Batteries: Contribution of Electronic Factors to the Battery Voltage. *J Electrochem Soc* [Internet]. 2019;166(3): A5308–A5312.
Available:<http://jes.ecsdl.org/lookup/doi/10.1149/2.0441903jes>
88. Elliott GK. Wood density in conifers. 1970; 1-44.
89. Hoadley RB. *Understanding Wood: A Craftman's Guide to Wood Technology*. 1980;1-256.
90. Record SJ. The Mechanical Properties of Wood, Including a Discussion of the Factors Affecting the Mechanical Properties, and Methods of Timber Testing. 2011;1-182.
91. Mainwaring D. Building Model Boats | Everyone should enjoy the pleasure of model boat building [Internet]. 2008 [cited 2019 Jan 24].
Available:<https://daveifm.wordpress.com/>
92. Agricola G. *De Re Metallica*. 1950;1-672.
93. V. Walther J. Earth's Natural Resources. 2013;1-428.
94. F.Tylecote R. *A History of Metallurgy* (2nd Edition). 2002;1-205.
95. B. Ross R. *Metallic Materials Specification Handbook*. 1992;1-830.
96. Gilbert Kaufman J. *Introduction to Aluminum Alloys and Tempers* 1st Edition. 2000;1-250.
97. F. Pollard S. *Boatbuilding with Aluminum: A Complete Guide for the Amateur and Small Shop*. 2006;1-336.
98. R. Davis J. *Alloying: Understanding the Basics*. 2001;1-647.
99. Paul Degarmo E, T Black J, A. Kohser R. *Materials and Processes in Manufacturing* 9th Edition Update Edition. 2003;1-1168.
100. Purvis J. *Model Shipbuilding in Steel - Hints, Tips & Technical* [Internet]. 2010 [cited 2019 Jan 24].
Available:<http://www.modelboats.co.uk/news/article/model-shipbuilding-in-steel/480>
101. Hollaway C. *Handbook of Polymer Composites for Engineers*. 1994;1-352.
102. Jones M. *Mechanics of Composite Materials*:2nd (Second) edition. 1994;1-643.
103. Kaw A. *Mechanics of Composite Materials* 2nd Edition. 2005;1-490.
104. Aird F. *Fiberglass & Other Composite Materials: A Guide to High Performance Non-Metallic Materials for Race Cars, Street Rods, Body Shops, Boats, and Aircraft*. 2006;1-160.
105. M. Mayer R. *Design with Reinforced Plastics: A Guide for Engineers and Designers*. 2012. 1-212 p.
106. Aksu S, Cannon S, Gardiner C, Gudze M. *Hull Material Selection for Replacement Patrol Boats - An Overview*. 2002;1–23.
107. Zong Z. AN INTRODUCTION TO SHIP HYDRODYNAMICS. 2017;1–167.
108. Frisk D, Tegehall L. Prediction of High-Speed Planing Hull Resistance and Running Attitude. 2015;1–51.
109. Tecnico. Flow around a ship hull: Viscous Resistance. 2010;1–38.
110. Faruk Sukas O, Kemal Kinaci O, Cakici F, Kemal Gokce M. Hydrodynamic assessment of planing hulls using overset grids. *Appl Ocean Res*. 2017;65:35–46.
111. B. Whitham G. *Linear and Nonlinear Waves*. 1974;1-636.
112. Rabaud M, Moisy F. Ship wakes: Kelvin or mach angle? *Phys Rev Lett*. 2013;110(21):2–5.
113. Rozman S. Wake pattern of a boat. 2009;1–12.
114. Ghadimi P, Tavakoli S, Dashtimanesh A. A Mathematical Scheme for Calculation of Lift of Planing Crafts with Large Mean Wetted Length and a Comparative Study of Effective Parameters. *Univers J Fluid Mech* 2. 2014;2:35–54.
115. Sponberg EW. THE DESIGN RATIOS. *Sponb Yacht Des INC* [Internet]. 2011;(January):1–51.
Available:<http://www.sponberg yacht design.com/THE>
116. Rousmaniere J. *The Annapolis Book of Seamanship: Fourth Edition*. 2014;1-416.
117. Carlton JS. *Marine Propellers and Propulsion*. Edition S, editor. 2007.
118. Jamali A. Investigation of propeller characteristics with different locations of the rudder; 2010.
119. Melin J. Modeling, control and state-estimation for an autonomous sailboat. 2015;1–52.
120. Gerber M. *Motor, Propeller, ESC, and Battery Sizing Introduction*; 2016.

- Available:<http://www.maclab.seas.ucla.edu/people/matt-gerber/>
121. IMPBA. RC Boat Racing. 2018;1–2.
 122. Cruz NA, Alves JC. Autonomous sailboats: An emerging technology for ocean sampling and surveillance. *Ocean* 2008. 2008;
 123. Arc-boat T, Wallingford HR. The ARC-Boat The ARC-Boat. 2018.
 124. Coggins L, Ghadouani A, Ghisalberti M. Bathymetry mapping using a GPS-sonar equipped remote control boat: Application in waste stabilisation ponds. European Geosciences Union General Assembly. 2014.
 125. V. Thurman H. Introductory Oceanography. 1997;1-544.
 126. Laxamana N. SONAR Technology for Fish Finders. 2018;1–77.
 127. Jackson D, Richardson M. High-Frequency Seafloor Acoustics. 2007;1-616.
 128. B. Halvorsen M, G. Zeddies D, N. Popper A. Effects of low frequency naval sonar exposure on three species of fish. *J Acoust Soc Am*. 2013;134(2):205–10.
 129. P. Hodges R. Underwater Acoustics: Analysis, Design and Performance of Sonar. 2010;1-372.
 130. Boat JB. Remote Control Bait Boat. 2018; 1–11.
 131. World RF. Lets Go RC Fishing. 2018;1–2.

© 2019 Eugene et al.; This is an Open Access article distributed under the terms of the Creative Commons Attribution License (<http://creativecommons.org/licenses/by/4.0>), which permits unrestricted use, distribution, and reproduction in any medium, provided the original work is properly cited.

Peer-review history:
The peer review history for this paper can be accessed here:
<http://www.sdiarticle3.com/review-history/47791>